

Wear studies on the likely performance of CFR-PEEK/CoCrMo for use as artificial joint bearing materials

S. C. Scholes · A. Unsworth

Received: 24 June 2008 / Accepted: 21 July 2008 / Published online: 14 August 2008
© Springer Science+Business Media, LLC 2008

Abstract It is well known that a reduction in the volume of wear produced by articulating surfaces in artificial joints is likely to result in a lower incidence of failure due to wear particle induced osteolysis. Therefore, new materials have been introduced in an effort to produce bearing surfaces with lower, more biologically acceptable wear. Polyetheretherketone (PEEK-OPTIMA) has been successfully used in a number of implant applications due to its combination of mechanical strength and biocompatibility. Pin-on-plate wear tests were performed on various combinations of PEEK-OPTIMA and carbon fibre reinforced PEEK-OPTIMA (CFR-PEEK) against various CoCrMo alloys to assess the potential of this material combination for use in orthopaedic implants. The PEEK/low carbon CoCrMo produced the highest wear. CFR-PEEK against high carbon or low carbon CoCrMo provided low wear factors. Pin-on-plate tests performed on ultra-high molecular weight polyethylene (UHMWPE) against CoCrMo (using comparable test conditions) have shown similar or higher wear than that found for CFR-PEEK/CoCrMo. This study gives confidence in the likelihood of this material combination performing well in orthopaedic applications.

Notations

k Material specific wear coefficient
 S_a Centre-line-average surface roughness

S_{rms} Root mean square surface roughness
 S_{sk} Skewness value of surface topography

1 Introduction

Total joint replacement surgery is becoming more common-place in the younger patient and, therefore, it is becoming necessary for artificial joints to last for many more years than the currently used designs. In artificial hip and knee joints implanted in patients under the ages of 50 and 55 years, 30.7% of hips and 15% of knees fail after 15 and 14 years, respectively leading to the need for revision surgery [1, 2]. For patients of all ages, failure is commonly found to be as a result of aseptic loosening [3, 4].

To improve the survivorship of joints in younger patients, alternative materials are being investigated. Polyetheretherketone (PEEK-OPTIMA) and carbon fibre reinforced-PEEK-OPTIMA (CFR-PEEK) have been introduced as potential bearing materials to replace ultra-high molecular weight polyethylene (UHMWPE) in some applications. A study by Howling et al. [5] showed that CFR-PEEK wear particles had no cytotoxic effects on the cells in culture suggesting that this material may cause little or no adverse tissue reaction and PEEK-OPTIMA has been used successfully in a number of implant applications due to its combination of mechanical strength and biocompatibility [6].

Pin-on-plate machines that provide both reciprocation and rotational motion represent a simple method to assess the wear of different material combinations for potential use as implantable devices such as joint prostheses [7–10]. The pin-on-plate machine does not recreate the exact loading and motion patterns experienced in the body, however,

S. C. Scholes (✉) · A. Unsworth
Centre for Biomedical Engineering, School of Engineering,
Durham University, Science Site, South Road,
Durham DH1 3LE, England
e-mail: s.c.scholes@durham.ac.uk

these machines will assess the wear that will occur when two materials come into sliding contact under similar sliding speeds and contact stresses to those observed in vivo. This allows a relatively fast, inexpensive method of ranking different material combinations in the laboratory.

In this study multi-directional pin-on-plate wear tests were performed on various combinations of PEEK-OPTIMA and CFR-PEEK (both pitch and PAN-based) against CoCrMo to assess the potential of this material combination for use in orthopaedic implants.

2 Materials and methods

The material combinations that were tested are shown in Table 1. The PEEK and CFR-PEEK (both pitch and PAN-based) specimens were provided by Invibio Ltd. and the low carbon (LC) and high carbon (HC) CoCrMo plates were manufactured from material supplied by DePuy and Smith and Nephew, respectively.

The wear tests were performed on a pin-on-plate machine (see Fig. 1) which provided both reciprocation and rotational motion. This multidirectional motion replicated the crossing of the friction vectors that would be experienced in vivo and, therefore, more accurately simulated the wear that might be expected. This machine has been described in greater detail elsewhere [11], however, four stations were set-up to apply the multidirectional motion as opposed to two [12]. Also, the rotational motion was applied through fixed gearing directly from the motor rather than the pulley and toothed belt system described by Joyce et al. [11]. In each test, four pin and plate samples were tested for 2 million cycles at a cycle frequency of approximately 1 Hz. A 40 N load was applied to each station which resulted in a contact stress of approximately 2 MPa. The stroke length was 25 mm.

The lubricant used was new born calf serum (supplied by Harlan Sera-Lab) diluted to 25% with distilled water to provide a protein content of 15 g l^{-1} . This was maintained at 37°C. Sodium azide (0.2%) was added to retard the growth of bacteria as was 20 mM EDTA to prevent calcium deposition. The amount of lubricant within the sample bath was controlled by a level sensor made from platinum wire allowing the lubricant to be maintained at an

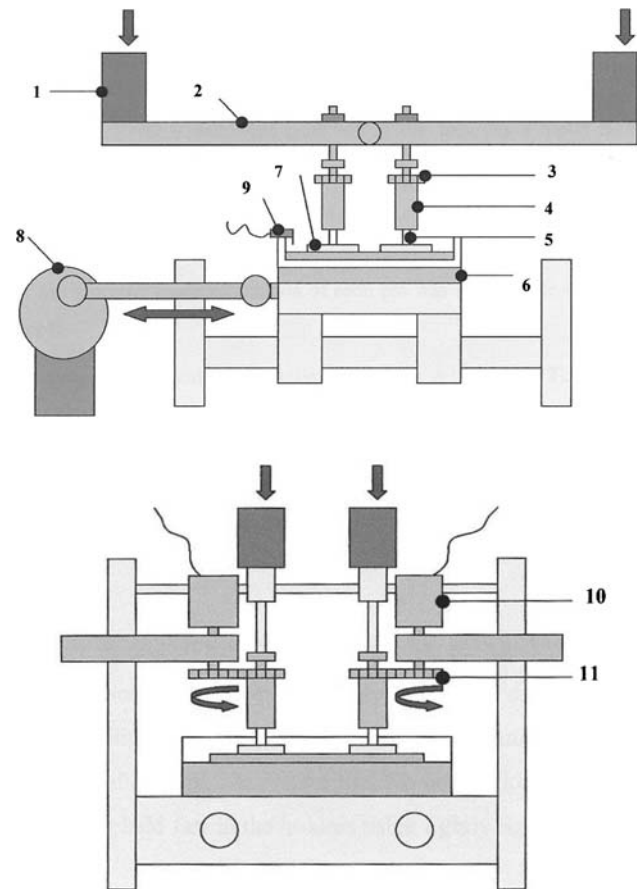

Fig. 1 Schematic diagram of the pin-on-plate machine (1, load cell; 2, lever arm; 3, gear; 4, pin holder; 5, pin; 6, heater bed; 7, plate; 8, motor to provide reciprocation; 9, level sensor; 10, motor; 11, gear) [12]

almost constant level by topping up when needed with distilled water.

The wear was assessed gravimetrically and converted to volumetric wear using the material density (see Table 2). At least twice a week (approximately every 0.25 million cycles) the machine was stopped to allow for cleaning and weighing of the samples. Any excess lubricant was cleaned from the lubricant baths and the pins and plates removed. The pin and plate samples were then cleaned and dried using the protocol outlined in the Appendix. They were then weighed three times on a Mettler Toledo AX 205 balance (accurate to 0.01 mg) and an average weight recorded. Control specimens were used to take account of any weight changes due to the immersion in the lubricated environment of both the pins and plates during the test. The machine was then reassembled and the lubricant refreshed.

The wear volumes were plotted against the number of cycles and the gradient of the line through the data (determined by linear regression analysis) provided the wear volume per cycle which was then converted to wear

Table 1 Material combinations used in this study

Pin material	Plate material
PEEK	Low carbon (LC) CoCrMo
CFR-PEEK PAN	Low carbon (LC) CoCrMo
CFR-PEEK PAN	High carbon (HC) CoCrMo
CFR-PEEK pitch	High carbon (HC) CoCrMo

Table 2 Material densities

Material	Density (kgm ⁻³)
PEEK	1,300
CFR-PEEK PAN	1,400
CFR-PEEK pitch	1,350
LC CoCrMo	7,970
HC CoCrMo	8,500

per metre sliding using the sliding distance per cycle (50 mm). This was then divided by the load to provide the wear factor, k (mm³ N⁻¹ m⁻¹). The changes in weight of the soak control pins and plates were taken into account in this calculation.

In addition to the weight loss measurements taken throughout the test that used soak control specimens to take into account any lubricant absorption, a vacuum oven drying technique was used to measure the weight loss of the dried samples. The weight loss measured using the dried samples would be the weight loss due to the wear alone and, therefore, this gave the ‘true’ wear of the pins and plates. Two of the four pairs of testing samples (from stations 1 and 2) were dried in the vacuum oven prior to wear testing. The components were then weighed and then put in bovine serum to soak before the wear test commenced. Only two (of the four) sets of samples were dried in the vacuum oven in case the vacuum oven drying technique affected the wear properties of the materials. After the wear test was complete, samples 1 and 2 were dried in the vacuum oven again and the final weight measurements were then recorded. These measurements allowed the ‘true’ weight loss to be measured and the ‘true’ wear factors to be calculated. These wear factors were then compared with those determined from the weight loss measurements taken during the test. Vacuum oven drying the samples prior to the wear test affected their lubricant absorption, therefore, samples 1 and 2 absorbed different amounts of lubricant than the non-vacuum oven dried samples 3 and 4. During the wear test, a control pin and plate were used to take into account any lubricant absorption that had occurred. As samples 1 and 2 absorbed different amounts of lubricant than samples 3 and 4, a separate set of control samples were used for the vacuum oven dried samples. These control samples were also dried in the vacuum oven to the same extent as the test samples and kept in the same environmental conditions as the testing samples throughout the test. The additional set of control samples used for stations 1 and 2 had a second use. Due to the lubricant absorption that occurred during the wear test, more drying time in the vacuum oven was necessary post-wear in order to dry the components to the same level as pre-wear testing. The control samples did not suffer any wear and so these samples acted as the

benchmark to allow the testing samples to be dried the same amount both pre and post-wear. In other words, once the control samples had reached the same weight within the vacuum oven post-wear testing as they had prior to testing, this was when the ‘true’ weight measurements were taken of the test samples 1 and 2. This weight loss was then converted to a wear factor.

Surface topography measurements were performed using a Zygo NewView 100 non-contacting 3D profilometer. The 10× lens with 2× zoom was used, giving an area of view of 0.366 × 0.272 mm. Ten measurements of S_a , S_q and S_{sk} were taken of each pin and plate of each material combination prior to testing. The surface measurements were then performed at one million cycles of testing and then at the end of the 2 million cycles test.

3 Results

Figures 2–6 show the volume loss versus number of cycles for both the pins and plates of all the material combinations tested in this study. These results show the wear of the components corrected relative to the control samples. Some

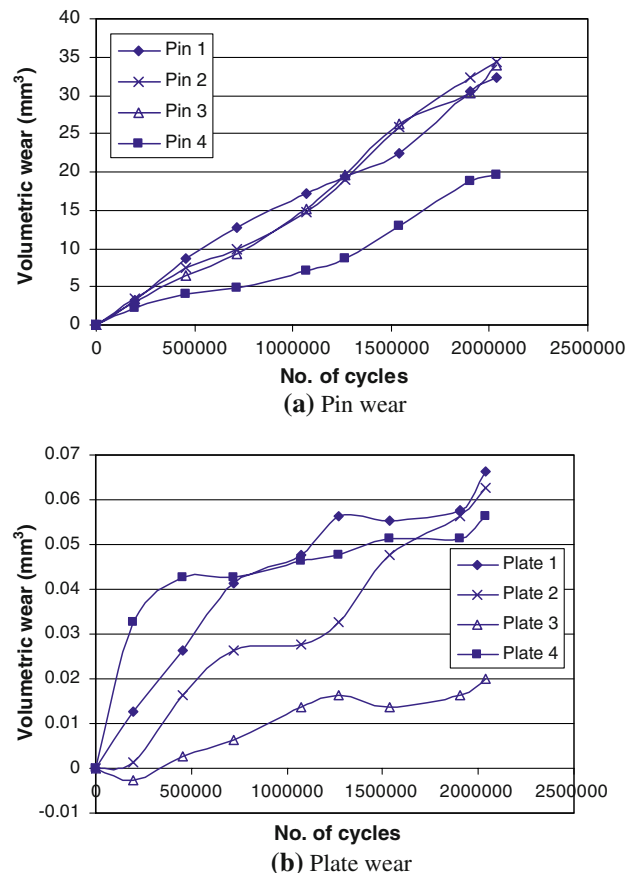

Fig. 2 Volume loss for the PEEK-OPTIMA pins (a) articulating against LC CoCrMo plates (b)

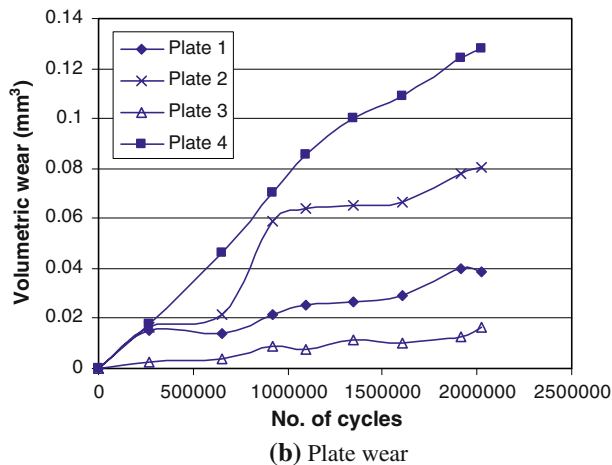
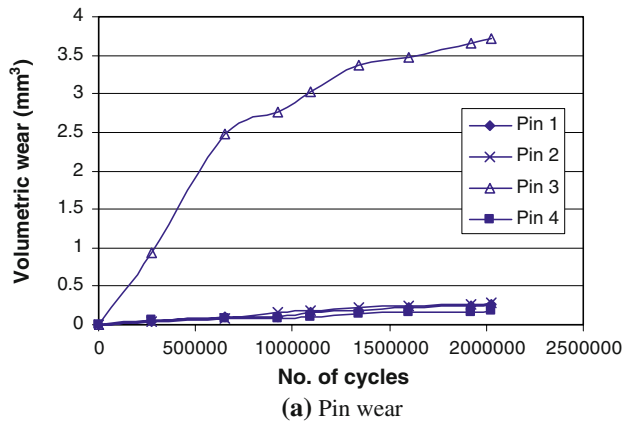

Fig. 3 Volume loss for the CFR-PEEK PAN pins (a) articulating against LC CoCrMo plates (b) (test 1)

of the tests exhibited two wear phases: the running-in wear followed by a lower steady-state wear. For those tests that did not show any running-in wear, the wear factors were calculated from the first wear measurement onwards. The steady-state wear factors found for each test are shown in Fig. 7 and Table 3 (average of four samples for each test).

Figure 2 shows the volumetric wear produced by PEEK/LC CoCrMo and Table 4 shows the average surface roughness measurements. This coupling produced high wear rates with no running-in wear phase. The average wear factors were 7.37 and $0.01 \times 10^{-6} \text{ mm}^3 \text{ N}^{-1} \text{ m}^{-1}$ for the pins and the plates respectively (ranges 4.83 – 8.60 and 0.005 – $0.015 \times 10^{-6} \text{ mm}^3 \text{ N}^{-1} \text{ m}^{-1}$). The average wear factors for the full test (samples 1 and 2) were 8.19 and $0.016 \times 10^{-6} \text{ mm}^3 \text{ N}^{-1} \text{ m}^{-1}$ and the vacuum oven drying measurements of these samples gave average wear factors of 8.26 and $0.019 \times 10^{-6} \text{ mm}^3 \text{ N}^{-1} \text{ m}^{-1}$. As can be seen from Table 4, the pin surfaces become smoother and the plate surfaces roughened after the start of the test.

Figure 3 shows the wear results from the CFR-PEEK pins articulating against the LC CoCrMo plates. Three of the testing samples showed no running-in wear period,

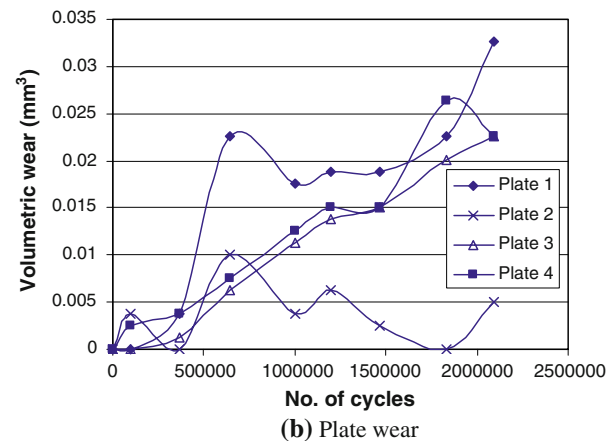
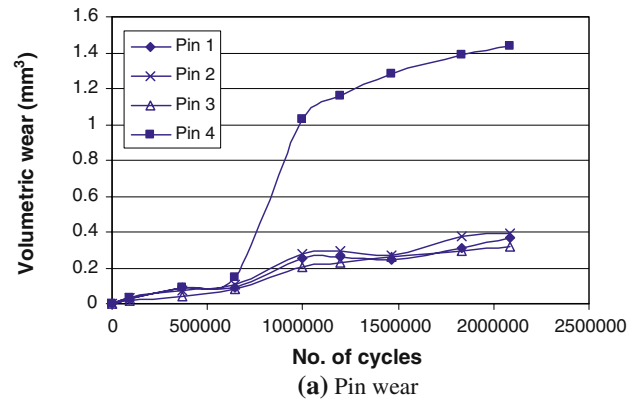

Fig. 4 Volume loss for the CFR-PEEK PAN pins (a) articulating against LC CoCrMo plates (b) (test 2)

however, one station gave a high running-in wear for just over 500,000 cycles and continued to produce higher wear than the other stations thereafter. The average steady-state wear factors for the pins and plates respectively were 0.209 and $0.0152 \times 10^{-6} \text{ mm}^3 \text{ N}^{-1} \text{ m}^{-1}$ (range 0.0403 – 0.685 and 0.0035 – $0.0313 \times 10^{-6} \text{ mm}^3 \text{ N}^{-1} \text{ m}^{-1}$). The average overall wear factors for samples 1 and 2 were 0.0671 and $0.0147 \times 10^{-6} \text{ mm}^3 \text{ N}^{-1} \text{ m}^{-1}$ for the pins and plates, respectively. The vacuum oven drying tests showed the average wear factors to be 0.0583 and $0.0150 \times 10^{-6} \text{ mm}^3 \text{ N}^{-1} \text{ m}^{-1}$. In this test, the surface roughness of the CFR-PEEK pins became smoother throughout the test but the CoCrMo plates became rougher, these results are shown in Table 5.

Due to the range of results given by the CFR-PEEK PAN/LC CoCrMo combination, this test was repeated with fresh samples and the results are shown in Fig. 4. No running-in wear period was apparent with these samples. Unfortunately, the machine ran dry shortly after 650,000 cycles and caused higher wear, however, the material wear before running dry was similar to that thereafter. Therefore, this high wear period has been ignored when calculating the wear factors. The average wear factors for the pins and

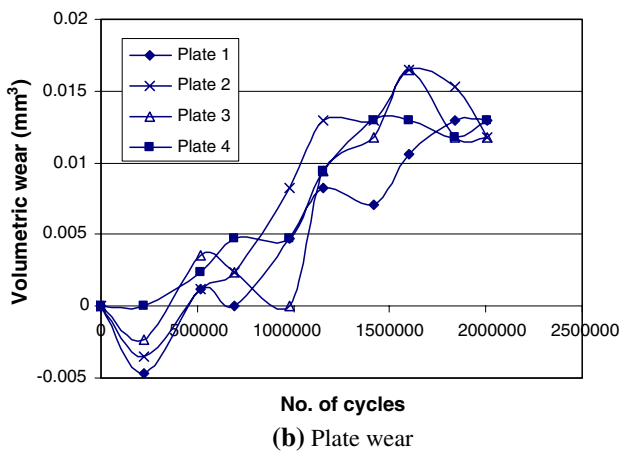
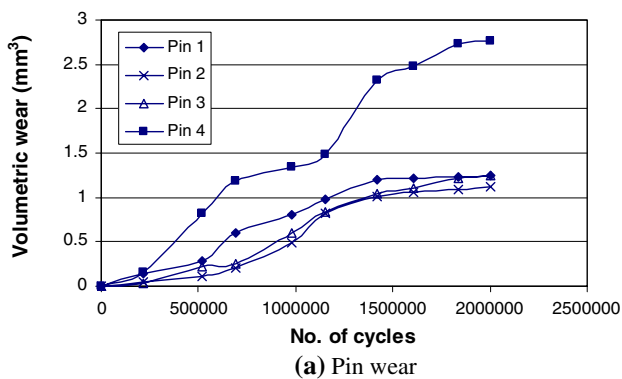

Fig. 5 Volume loss for the CFR-PEEK PAN pins (a) articulating against HC CoCrMo plates (b)

the plates respectively were 0.0793 and $0.0071 \times 10^{-6} \text{ mm}^3 \text{ N}^{-1} \text{ m}^{-1}$ (ranges $0.044\text{--}0.161$ and $0.00161\text{--}0.0160 \times 10^{-6} \text{ mm}^3 \text{ N}^{-1} \text{ m}^{-1}$). The vacuum oven drying tests gave average wear factors of 0.0983 and 0.0143 compared with 0.0906 and $0.0045 \times 10^{-6} \text{ mm}^3 \text{ N}^{-1} \text{ m}^{-1}$ (the average overall wear factors for samples 1 and 2 as measured during the test). The average wear factors produced in the previous test for the same material combination were 0.209 and $0.0152 \times 10^{-6} \text{ mm}^3 \text{ N}^{-1} \text{ m}^{-1}$ (range $0.0403\text{--}0.685$ and $0.0035\text{--}0.0313 \times 10^{-6} \text{ mm}^3 \text{ N}^{-1} \text{ m}^{-1}$). The first test gave a larger range of wear factors for the pins than was found in this test. The surface roughness values for the samples in this test are shown in Table 6. These were found to be very similar to those found in the first CFR-PEEK PAN/LC CoCrMo test.

Figure 5 shows the results for CFR-PEEK PAN against HC CoCrMo. The running-in wear period was the first 1.4 million cycles and was $0.476 \times 10^{-6} \text{ mm}^3 \text{ N}^{-1} \text{ m}^{-1}$ for the pins and $0.00491 \times 10^{-6} \text{ mm}^3 \text{ N}^{-1} \text{ m}^{-1}$ for the plates. The steady-state wear factors thereafter were $0.176 \times 10^{-6} \text{ mm}^3 \text{ N}^{-1} \text{ m}^{-1}$ for the pins and $0.00057 \times 10^{-6} \text{ mm}^3 \text{ N}^{-1} \text{ m}^{-1}$ for the plates (ranges $0.0325\text{--}0.4$ and -0.00131 to $0.00508 \times 10^{-6} \text{ mm}^3 \text{ N}^{-1} \text{ m}^{-1}$). Vacuum oven drying the samples gave total wear factors of 0.299 and

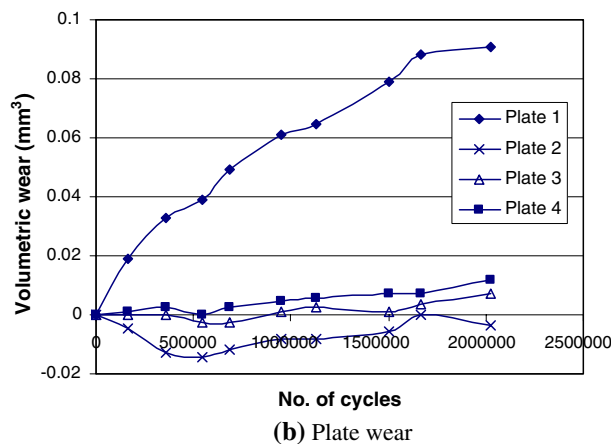
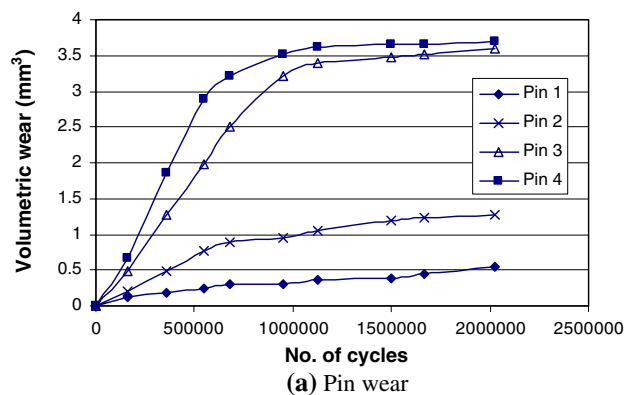

Fig. 6 Volume loss for the CFR-PEEK pitch pins (a) articulating against HC CoCrMo plates (b)

$0.00646 \times 10^{-6} \text{ mm}^3 \text{ N}^{-1} \text{ m}^{-1}$ which compares with $0.294 \times 10^{-6} \text{ mm}^3 \text{ N}^{-1} \text{ m}^{-1}$ for the pins and $0.00308 \times 10^{-6} \text{ mm}^3 \text{ N}^{-1} \text{ m}^{-1}$ for the plates found using the standard cleaning/weighing protocol. Again, the surface topography results (see Table 7) showed a reduction in roughness of the pins and a slight increase in the plate surface roughness during the test.

The results for CFR-PEEK pitch against HC CoCrMo are shown in Fig. 6. As can be seen, there are two distinct wear phases. The higher initial wear phase lasted for approximately one million cycles followed by a lower steady-state wear phase. The initial, running-in wear was $1.11 \times 10^{-6} \text{ mm}^3 \text{ N}^{-1} \text{ m}^{-1}$ for the pins and $0.00697 \times 10^{-6} \text{ mm}^3 \text{ N}^{-1} \text{ m}^{-1}$ for the plates (ranges $0.160\text{--}1.98$ and $-0.00465\text{--}0.0308 \times 10^{-6} \text{ mm}^3 \text{ N}^{-1} \text{ m}^{-1}$). The steady-state wear gave average wear factors of $0.123 \times 10^{-6} \text{ mm}^3 \text{ N}^{-1} \text{ m}^{-1}$ for the pins and $0.00588 \times 10^{-6} \text{ mm}^3 \text{ N}^{-1} \text{ m}^{-1}$ for the plates (ranges $0.0785\text{--}0.162$ and $0.0029\text{--}0.0152 \times 10^{-6} \text{ mm}^3 \text{ N}^{-1} \text{ m}^{-1}$). The vacuum oven drying technique gave a total wear of $0.235 \times 10^{-6} \text{ mm}^3 \text{ N}^{-1} \text{ m}^{-1}$ for the pins and $0.0154 \times 10^{-6} \text{ mm}^3 \text{ N}^{-1} \text{ m}^{-1}$ for the plates. This compares with the weight measurements taken during the wear test (using the

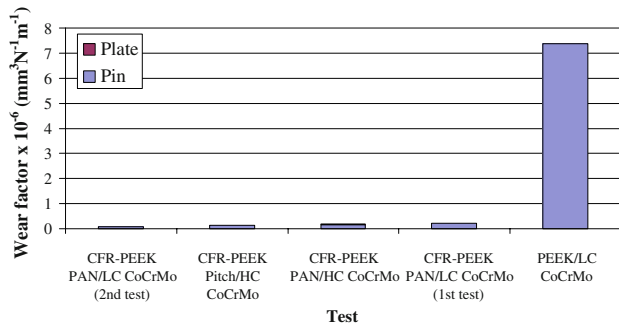

Fig. 7 Wear results for all material combinations

Table 3 Wear results for all tests

Test couple	Wear factors ($\times 10^{-6} \text{ mm}^3 \text{ N}^{-1} \text{ m}^{-1}$)	
	Pin	Plate
PEEK/LC CoCrMo	7.37	0.010
CFR-PEEK PAN/LC CoCrMo (test 1)	0.209	0.0152
CFR-PEEK PAN/LC CoCrMo (test 2)	0.0793	0.0071
CFR-PEEK PAN/HC CoCrMo	0.176	0.00057
CFR-PEEK pitch/HC CoCrMo	0.123	0.00588

Table 4 Surface roughness values for PEEK-OPTIMA/LC CoCrMo

No. of cycles (million)	S_q (μm)	S_a (μm)	S_{sk}
(a) Pin			
0	1.248	0.834	0.285
1	0.012	0.005	1.440
2	0.010	0.005	-1.786
(b) Plate			
0	0.008	0.006	-0.572
1	0.074	0.059	-0.377
2	0.067	0.054	-0.316

Table 5 Surface roughness values for CFR-PEEK PAN/LC CoCrMo, test 1

No. of cycles (million)	S_q (μm)	S_a (μm)	S_{sk}
(a) Pin			
0	1.768	1.273	-1.053
1	0.241	0.160	-2.571
2	0.170	0.103	-4.297
(b) Plate			
0	0.006	0.005	-0.062
1	0.034	0.026	-0.387
2	0.041	0.032	-0.667

Table 6 Surface roughness values for CFR-PEEK PAN/LC CoCrMo, test 2

No. of cycles (million)	S_q (μm)	S_a (μm)	S_{sk}
(a) Pin			
0	1.841	1.289	-1.803
1	0.223	0.125	-3.942
2	0.160	0.106	-3.732
(b) Plate			
0	0.007	0.006	-0.110
1	0.041	0.031	-1.212
2	0.027	0.021	-0.726

Table 7 Surface roughness values for CFR-PEEK PAN/HC CoCrMo

No. of cycles (million)	S_q (μm)	S_a (μm)	S_{sk}
(a) Pin			
0	0.981	0.628	-1.696
1	0.095	0.070	0.004
2	0.120	0.082	-1.395
(b) Plate			
0	0.015	0.011	0.800
1	0.024	0.017	-0.943
2	0.031	0.021	-0.163

Table 8 Surface roughness values for CFR-PEEK pitch/HC CoCrMo

No. of cycles (million)	S_q (μm)	S_a (μm)	S_{sk}
(a) Pin			
0	1.099	0.771	-1.169
1	0.152	0.089	-3.122
2	0.252	0.114	-6.422
(b) Plate			
0	0.014	0.010	0.449
1	0.029	0.021	-0.530
2	0.036	0.028	-0.548

soak control) of $0.225 \times 10^{-6} \text{ mm}^3 \text{ N}^{-1} \text{ m}^{-1}$ for the pins and $0.0107 \times 10^{-6} \text{ mm}^3 \text{ N}^{-1} \text{ m}^{-1}$ for the plates. The surface topography results (Table 8) showed a reduction in surface roughness of the pins after the start of the test which then remained similar until the end of the test. The pins also showed a move to a more negatively skewed surface. The plates showed a slight increase in surface roughness.

4 Discussion

The PEEK/LC CoCrMo produced the highest wear of all the material combinations tested. Pin-on-plate tests

performed by Joyce et al. [11] that studied the wear of UHMWPE/stainless steel showed an average wear factor of $1.1 \times 10^{-6} \text{ mm}^3 \text{ N}^{-1} \text{ m}^{-1}$. The average wear produced by the PEEK-on-LC CoCrMo samples was approximately seven times higher than this. In hip simulator studies performed by Wang et al. [13] the hard counterface (alumina) against PEEK joints gave wear rates that were approximately eight times higher than the UHMWPE cups. Therefore, the pin-on-plate tests and the hip simulator studies show similar wear rankings for this material combination.

Two tests were performed on the CFR-PEEK PAN/LC CoCrMo. For these two tests, the average pin wear found for CFR-PEEK PAN/LC CoCrMo was $0.144 \times 10^{-6} \text{ mm}^3 \text{ N}^{-1} \text{ m}^{-1}$. The two tests were performed because one of the stations in the initial test gave much higher wear than the other three and, therefore, more test samples were needed to give a fairer average wear factor. The average wear factor for the CFR-PEEK PAN pins in the first test was $0.209 \times 10^{-6} \text{ mm}^3 \text{ N}^{-1} \text{ m}^{-1}$ (range $0.0403\text{--}0.685 \times 10^{-6} \text{ mm}^3 \text{ N}^{-1} \text{ m}^{-1}$). However, when the wear produced by the highest wearing station is ignored the average pin wear is $0.0506 \times 10^{-6} \text{ mm}^3 \text{ N}^{-1} \text{ m}^{-1}$ which is close to the value found in the second CFR-PEEK PAN/LC CoCrMo test ($0.0793 \times 10^{-6} \text{ mm}^3 \text{ N}^{-1} \text{ m}^{-1}$). The second CFR-PEEK PAN/LC CoCrMo test gave the lowest average wear out of all the material combinations tested in this study.

Both PAN and pitch-based CFR-PEEK pins were tested against the high carbon CoCrMo plates and compared against each other. The pitch-based material gave a higher running-in wear factor than the PAN-based material but the running-in wear phase was shorter for the pitch material (approximately 1 million cycles compared with 1.4 million cycles). After the running-in wear period, the pitch-based material gave slightly lower results than the PAN-based material (total pin and plate wear 0.129 compared with $0.177 \times 10^{-6} \text{ mm}^3 \text{ N}^{-1} \text{ m}^{-1}$). When comparing the PAN-based material results against HC CoCrMo with those for the PAN-based material versus the LC CoCrMo plates, the high carbon CoCrMo produced similar CFR-PEEK pin wear to the average wear produced against the low carbon material (0.176 c.f. $0.144 \times 10^{-6} \text{ mm}^3 \text{ N}^{-1} \text{ m}^{-1}$). However, when the higher wearing station in the LC CoCrMo test is ignored, the HC CoCrMo plates produced higher pin wear than when articulating against the low carbon plates (0.176 c.f. $0.0670 \times 10^{-6} \text{ mm}^3 \text{ N}^{-1} \text{ m}^{-1}$). The high carbon material had protruding blocky carbides whereas the low carbon material did not. The protruding carbides on the high carbon CoCrMo plates may have caused this increase in wear.

Several studies have assessed the wear of UHMWPE against stainless steel under comparable conditions and found similar or slightly higher wear rates than those found in this study (0.212-- approximately $2 \times 10^{-6} \text{ mm}^3 \text{ N}^{-1} \text{ m}^{-1}$

c.f. $0.0793\text{--}0.209 \times 10^{-6} \text{ mm}^3 \text{ N}^{-1} \text{ m}^{-1}$) [11, 14–16]. The study reported by Vassiliou et al. [14] found higher wear rates for the UHMWPE pin and similar wear for the metal plate. However, only one set of samples was tested and this current study has shown that this is not necessarily sufficient to assess the true wear characteristics of a material combination as the CFR-PEEK pins articulating against LC CoCrMo gave a wide range of wear factors ($0.0403\text{--}0.685 \times 10^{-6} \text{ mm}^3 \text{ N}^{-1} \text{ m}^{-1}$).

Other researchers have found that CFR-PEEK is a low wearing material. Marques and Davim [17] tested it against steel on a pin-on-disk machine and found it produced lower wear than UHMWPE-on-steel. Their test, however, used distilled water as the lubricating fluid and unidirectional motion.

Scholes et al. [12] tested CFR-PEEK (both PAN and pitch-based) against ceramic plates on a multi-directional pin-on-plate machine. These material combinations gave very similar test results to those found in this study against the metal counterfaces. The alumina-on-CFR-PEEK hips studied by Wang et al. [13] gave the lowest wear of the different material combinations tested with the 30 wt.% fibre reinforced composite cups (a similar material to that tested in this study) giving wear rates of at least one order of magnitude lower than the UHMWPE cups. In a long-term wear simulator study by Scholes et al. [18], BioLox Forte femoral heads against pitch-based CFR-PEEK acetabular cups produced very low wear ($1.16 \text{ mm}^3/\text{million cycles}$). As the pin-on-plate test results for the CFR-PEEK pins against the metal plates are similar to those against the ceramic plates, these test results imply that a metal-on-CFR-PEEK material combination is likely to perform well as an articulating joint prosthesis.

Pin-on-plate machines are simple devices that allow the assessment of the wear performance of different material combinations. Although they provide the first step towards evaluating these materials, further tests will be necessary to determine their likely performance in specific situations. Further research has been performed assessing the tribological properties of a pitch-based CFR-PEEK-on-CoCrMo mobile unicondylar knee joint [19]. This joint combination provided lower wear rates than conventional metal-on-UHMWPE joints which is a positive, encouraging result.

The possibility of introducing CFR-PEEK as the bearing surface in articulating joints, as an alternative to UHMWPE, is being investigated to attempt to reduce aseptic loosening caused by osteolysis. It is, therefore, important that the CFR-PEEK particles produced by the surface asperity contact are low in volume and biologically compatible so as not to cause an immune response. The tests performed by Howling et al. [5] compared

CFR-PEEK wear particles to UHMWPE and showed that CFR-PEEK wear particles had no cytotoxic effects on the cells in culture. A recent review paper [6] discussed several tests performed on the bioactivity of CFR-PEEK as a bulk material. The tests reported [20–23] showed good in vitro biocompatibility of the cell culture models and the work performed by Sagomonyants [24] showed that implantable grade CFR-PEEK had comparable in vitro bone forming capacity of rough titanium. In fact, the work performed by Morrison et al. [21] suggested some stimulatory effects from this material on osteoblastic activity. Although these are promising results, more work needs to be done to determine what effects the particles produced by these bearing surfaces may have on the body.

5 Conclusions

CFR-PEEK against CoCrMo (HC or LC) provided low wear rates. This study gives confidence in the likelihood of this material combination performing well in orthopaedic applications.

Acknowledgements The authors would like to thank Invibio Ltd., DePuy and Smith and Nephew for supplying the material for these tests and Invibio Ltd. for funding this work.

Appendix

Cleaning/drying/weighing protocol for pin and plate samples

- Rinse with tap water to remove bulk contaminants.
- Wash in an ultrasonic cleaner in a solution of 1% detergent for 15 min.
- Rinse in a stream of distilled water.
- Rinse in an ultrasonic cleaner in distilled water for 5 min.
- Rinse in a stream of distilled water.
- Dry with lint-free tissue.
- Air-dry in a dust-free environment at room temperature for 30 min.
- Take three weight measurements using the Mettler Toledo AX205 balance.

References

1. J. Kärrholm, G. Garellick, P. Herberts, Swedish Hip Arthroplasty Register Annual Report 2006, p. 58
2. T.J. Gie, C. Novak, P. Sinner, W. Ma, S. Mehle, *Clin Orthop Relat Res* **464**, 83 (2007)
3. D.J. Berry, W.S. Harmsen, M.E. Cabanela, B.F. Morrey *J Bone Joint Surg Am Vol (CD-ROM Ed)* **84A**, 171 (2002)
4. V.I. Roberts, C.N.A. Esler, W.M. Harper, *J Bone Joint Surg* **89-B**, 1452 (2007). doi:10.1302/0301-620X.89B11.19783
5. G.I. Howling, H. Sakoda, A. Antonarrulrajah, H. Marrs, T.D. Stewart, S. Appleyard et al., *J Biomed Mater Res Part B Appl Biomater* **67B**, 758 (2003). doi:10.1002/jbm.b.10068
6. S.M. Kurtz, J.N. Devine, *Biomaterials* **28**, 4845 (2007). doi:10.1016/j.biomaterials.2007.07.013
7. A. Wang, C. Stark, J.H. Dumbleton, *Proc Inst Mech Eng* **210**, 141 (1996). doi:10.1243/PIME_PROC_1996_210_407_02
8. V. Saikko, *J Biomed Mater Res* **41**, 58 (1998). doi:10.1002/(SICI)1097-4636(199807)41:1<58::AID-JBM7>3.0.CO;2-P
9. J.L. Tipper, P.J. Firkins, E. Ingham, J. Fisher, M.H. Stone, R. Farrar, *J Mater Sci Mater Med* **10**, 353 (1999). doi:10.1023/A:1026473723777
10. S.C. Scholes, A. Unsworth, *J Mater Sci Mater Med* **12**, 299 (2001). doi:10.1023/A:1011238902803
11. T.J. Joyce, D. Monk, S.C. Scholes, A. Unsworth, *Biomed Mater Eng* **10**, 241 (2000)
12. S.C. Scholes, A. Unsworth, *Proc Inst Mech Eng Part H-J Eng Med* **221**, 281 (2007). doi:10.1243/09544119JEIM224
13. A. Wang, R. Lin, V.K. Polineni, A. Essner, C. Stark, J.H. Dumbleton, *Tribol Int* **31**, 661 (1999). doi:10.1016/S0301-679X(98)00088-7
14. K. Vassiliou, A. Unsworth, *Proc Inst Mech Eng Part H-J Eng Med* **218**, 101 (2004). doi:10.1243/095441104322983997
15. V. Saikko, *Proc Inst Mech Eng Part H-J Eng Med* **220**, 723 (2006)
16. J.H. Ingram, M. Stone, J. Fisher, E. Ingham, *Biomaterials* **25**, 3511 (2004). doi:10.1016/j.biomaterials.2003.10.054
17. N. Marques, J.P. Davim, *Key Eng Mater* **230–232**, 487 (2002)
18. S.C. Scholes, I.A. Inman, A. Unsworth, E. Jones, *Proc. Inst. Mech. Eng. Part H-J. Eng Med* **222**, 273 (2008)
19. S.C. Scholes, A. Unsworth (2008) *Proc. Instn. Mech. Engrs. Journal of Engineering in Medicine (under review)*
20. L.M. Wenz, K. Merritt, S.A. Brown, A. Moet, A.D. Steffee, *J Biomed Mater Res* **24**, 207 (1990). doi:10.1002/jbm.820240207
21. C. Morrison, R. Macnair, C. MacDonald, A. Wykman, I. Goldie, M.H. Grant, *Biomaterials* **16**, 987 (1995). doi:10.1016/0142-9612(95)94906-2
22. R. Macnair, R. Wilkinson, C. MacDonald, I. Goldie, D.B. Jones, M.H. Grant, *Cells Mater* **6**, 71 (1996)
23. C.A. Scotchford, M.J. Garle, J. Batchelor, J. Bradley, D.M. Grant, *Biomaterials* **24**, 4871 (2003). doi:10.1016/S0142-9612(02)00488-X
24. K.B. Sagomonyants, M.L. Jarman-Smith, J.N. Devine, M.S. Aronow, G.A. Gronowicz, *Biomaterials* **29**, 1563 (2008). doi:10.1016/j.biomaterials.2007.12.001